



Emergency Visibility and Exit Signs

Photoluminescent Products to meet international building codes including:-

- Emergency Visibility Products
- Egress Path Markers
- UL924 Signs
- Fire Protection Signs
- Disaster Preparedness Signs

 **ecoglo**[®]
VISIBLY BETTER

www.ecoglo.ph
www.ecogloasia.com

Completed Projects Using Ecoglo Products



1. Supreme Court, Singapore
2. US Bank Tower, Los Angeles
3. Burj Khalifa, Dubai
4. Venetian Macao, Macau
5. Eaton Centre, Toronto
6. Yuen Long MTR Station, Hong Kong
7. MCG, Melbourne

ecoglo[®]
VISIBLY BETTER

About Ecoglo

Ecoglo Fire Protection Product Trading (EFPPT) was established in February 2019. EFPPT is the authorised representative of Ecoglo International and is located in Rizal Philippines. As well as servicing the Philippines, EFPPT is co-ordinating Ecoglo's expansion into the ASEAN market. The owners and staff of EFPPT have undergone induction and training relating to photoluminescent systems, Ecoglo products and the installation of those products.

Established in 1997, Ecoglo designs and manufactures photoluminescent (PL) exit signs and emergency visibility products using High Temperature Curing (HTC) technology to integrally bond Purpose Designed Polymers (PDP) to the aluminium base. This results in products with very high light storage capabilities and unparalleled durability.

Performance solutions can be engineered to meet emergency visibility requirements in performance based building codes worldwide. Ecoglo offers products to meet NFPA 101 Life Safety Code Solutions and IFC Solutions which includes our patented HTC product set alongside a range of PVC tapes and products.

Locally, Ecoglo clients include:

- Philippine Sports Commission
- Public Safety Mutual Benefit Fund. Inc.
- Gotesco Regency Twin Towers
- De La Salle University - Laguna Campus
- Government Service Insurance System
- Chubb Asia Pacific Pte Ltd
- Rt Baldoza Builders
- McMaster Machineries and Supplies, Inc.
- The Lind Hotels
- Amazon PHL
- Calapan Port (PPA)
- Cebu Port Authority
- University of Santo Tomas
- Thermax Industrial Products Inc.
- Esta Fine Color Corp
- Nutrivet Chemical Industries Inc.
- M + J Arkitekts
- Moment Group of Restaurants
- Integrated Market Services (Philippines) Inc. (IMSPI)
- Transworld Systems Customer Services Phil's LLC
- TRI-R Engineering & Industrial Supply

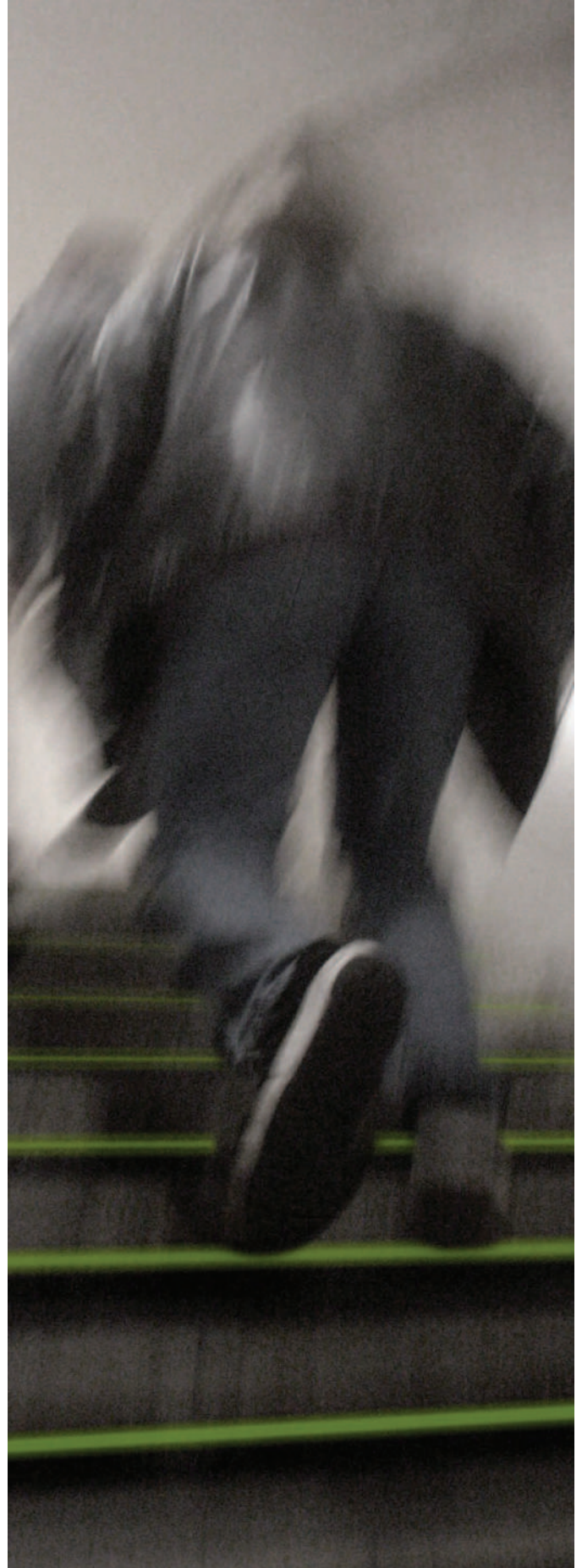

Step Edge Products PL and Anti-slip

F15-175 Step Nosing 75mm x 33mm

Available in standard lengths from 800mm to 1500mm in 100mm increments

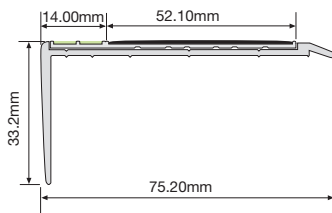
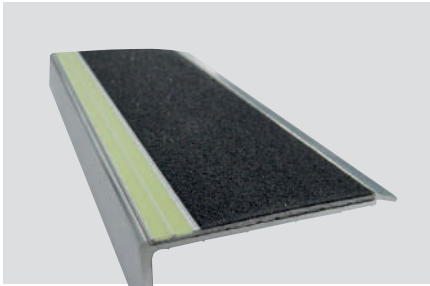

- Supplied pre-drilled with fixers.
- Adhesive and caulking gun available separately
- Custom cutting is available from 2450mm and 3060mm lengths

F14-175 Step Nosing 75mm x 10mm

Available in standard lengths from 800mm to 1500mm in 100mm increments

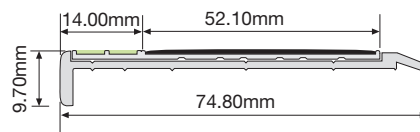
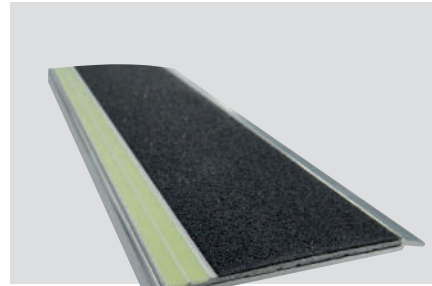

- Supplied pre-drilled with fixers.
- Adhesive and caulking gun available separately
- Custom cutting is available from 2450mm and 3060mm lengths

F9-171 Step Nosing 50mm x 25mm

Available in standard lengths from 800mm to 1500mm in 100mm increments

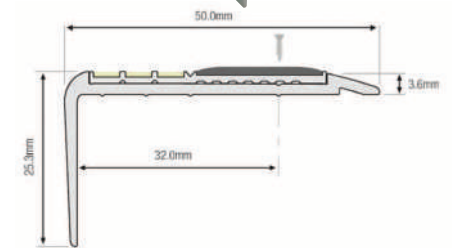
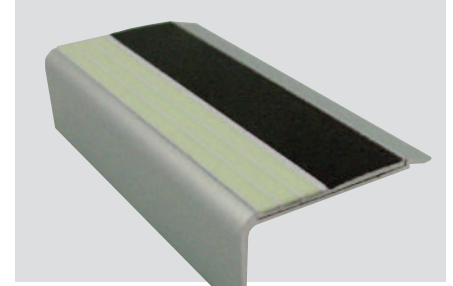

- Supplied pre-drilled with fixers.
- Adhesive and caulking gun available separately
- Custom cutting is available from 2450mm and 3060mm lengths

F15-173 Step Nosing 75mm x 33mm

Available in standard lengths from 800mm to 1500mm in 100mm increments

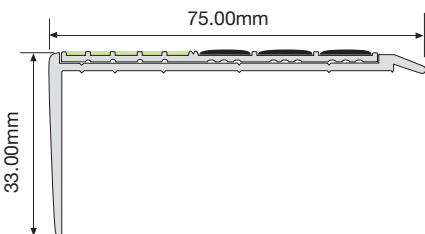

- Supplied pre-drilled with fixers.
- Adhesive and caulking gun available separately
- Custom cutting is available from 2450mm and 3060mm lengths

F14-173 Step Nosing 75mm x 10mm

Available in standard lengths from 800mm to 1500mm in 100mm increments

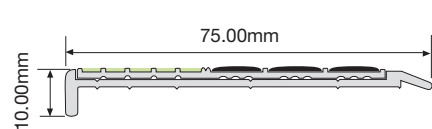
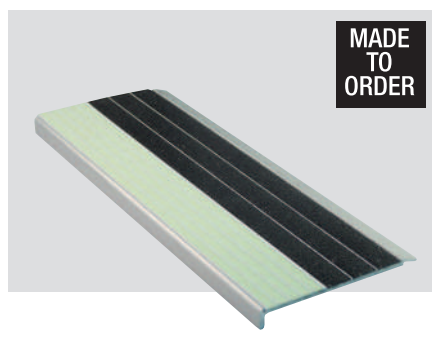

- Supplied pre-drilled with fixers.
- Adhesive and caulking gun available separately
- Custom cutting is available from 2450mm and 3060mm lengths

E2-071 Step Edge Contrast 37mm

Available in standard lengths from 800mm to 1500mm in 100mm increments

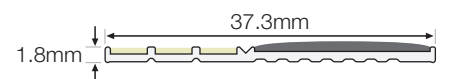
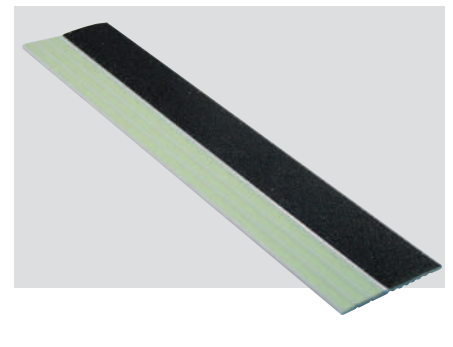

- Adhesive and caulking gun available separately
- Custom cutting is available from 2450mm and 3060mm lengths

E2-071 Polyurethane adhesive fixing
E2-071P Punched for screw fixing

For compliance information see product data sheets (downloadable from PRODUCTS section on website)

Step Edge Products PL and Anti-slip

E14-075 Step Edge Contrast 64mm

Available in standard lengths from 800mm to 1500mm in 100mm increments

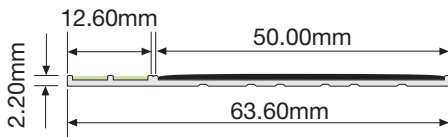
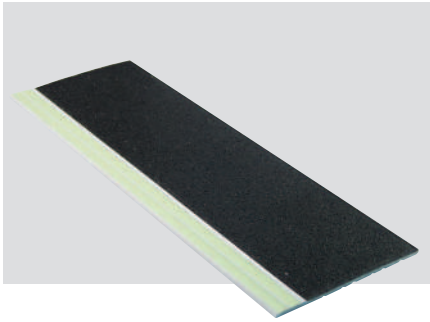

- Adhesive and caulking gun available separately
- Custom cutting is available from 2450mm and 3060mm lengths

E14-075 Polyurethane adhesive fixing
E14-075P Punched for screw fixing

E15-073 Step Edge Contrast 64mm

Available in standard lengths from 800mm to 1500mm in 100mm increments

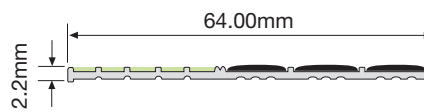
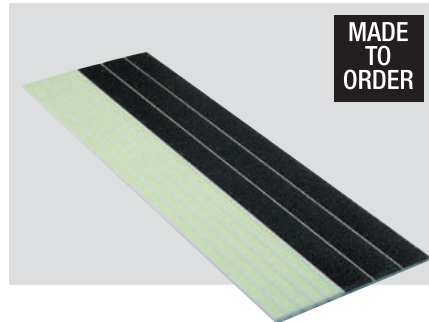

- Supplied pre-drilled with fixers.
- Adhesive and caulking gun available separately
- Custom cutting is available from 2450mm and 3060mm lengths

F15-155 Step Nosing 75mm x 33mm

Available in standard lengths from 800mm to 1500mm in 100mm increments

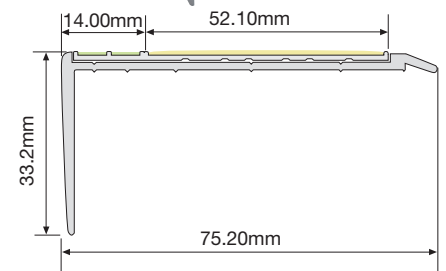
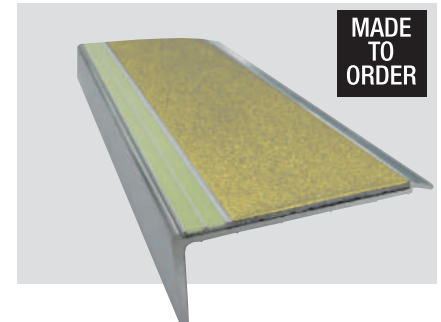

- Supplied pre-drilled with fixers.
- Adhesive and caulking gun available separately
- Custom cutting is available from 2450mm and 3060mm lengths

F14-155 Step Nosing 75mm x 10mm

Available in standard lengths from 800mm to 1500mm in 100mm increments

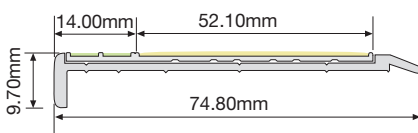
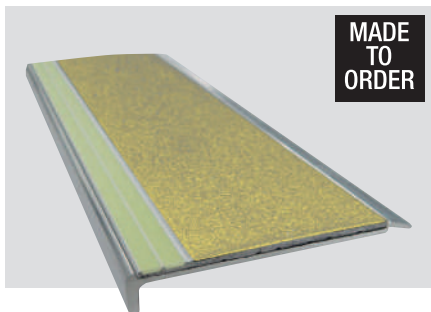

- Supplied pre-drilled with fixers.
- Adhesive and caulking gun available separately
- Custom cutting is available from 2450mm and 3060mm lengths

E14-055 Step Edge Contrast 64mm

Available in standard lengths from 800mm to 1500mm in 100mm increments

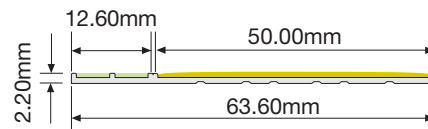
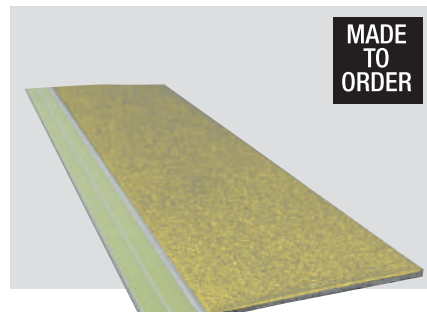

- Adhesive and caulking gun available separately
- Custom cutting is available from 2450mm and 3060mm lengths

E14-055 Polyurethane adhesive fixing
E14-055P Punched for screw fixing

S5-LM22080 L Marker

Available in a pack containing 10 x left side L Markers and 10 x right side L Markers

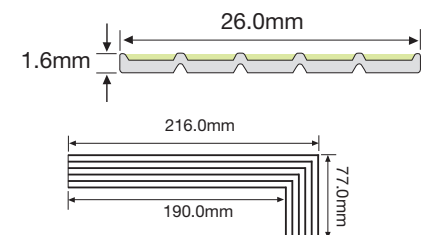
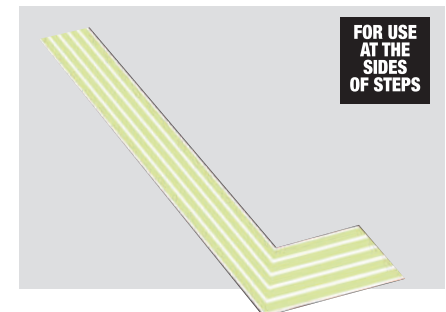

- Supplied as a straight length for folding into shape
- Adhesive and caulking gun sold separately

S5-LM22080 Polyurethane adhesive fixing

For compliance information see product data sheets (downloadable from PRODUCTS section on website)

Step Edge Products Anti-slip only

Note: The following products are not Emergency Visibility products as they contain no PL but are suitable for use on step-edges to help prevent slips and falls in all weather conditions.

F15-170 Step Nosing 75mm x 33mm

Available in standard lengths from 800mm to 1500mm in 100mm increments

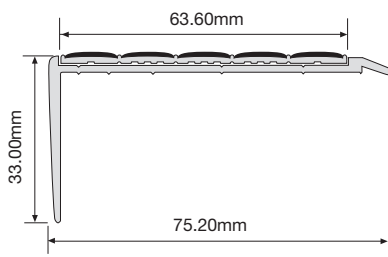
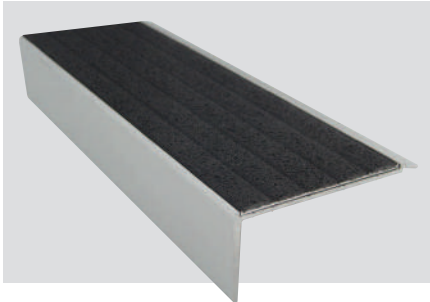

- Supplied pre-drilled with fixers.
- Adhesive and caulking gun available separately
- Custom cutting is available from 2450mm and 3060mm lengths

F15-150 Step Nosing 75mm x 33mm

Available in standard lengths from 800mm to 1500mm in 100mm increments

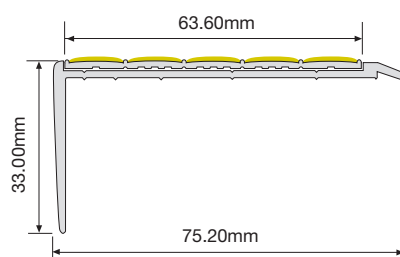
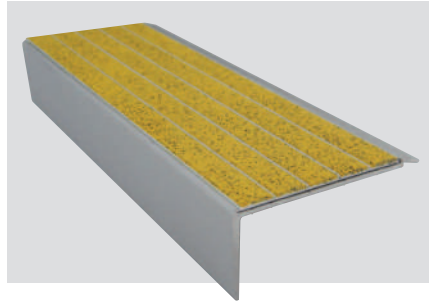

- Supplied pre-drilled with fixers.
- Adhesive and caulking gun available separately
- Custom cutting is available from 2450mm and 3060mm lengths

F14-170 Step Nosing 75mm x 10mm

Available in standard lengths from 800mm to 1500mm in 100mm increments

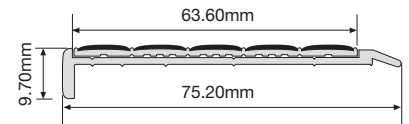

- Supplied pre-drilled with fixers.
- Adhesive and caulking gun available separately
- Custom cutting is available from 2450mm and 3060mm lengths

F14-150 Step Nosing 75mm x 10mm

Available in standard lengths from 800mm to 1500mm in 100mm increments

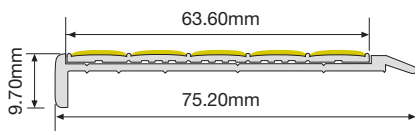
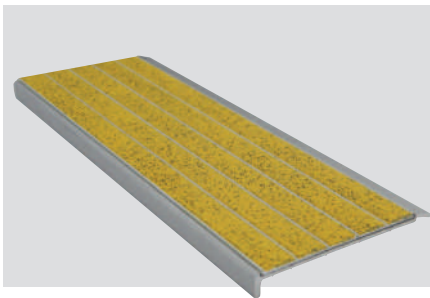

- Supplied pre-drilled with fixers.
- Adhesive and caulking gun available separately
- Custom cutting is available from 2450mm and 3060mm lengths

N15-070 Step Edge Contrast 64mm

Available in standard lengths from 800mm to 1500mm in 100mm increments

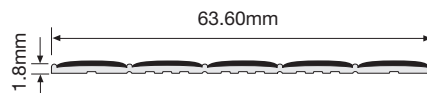

- Adhesive and caulking gun available separately
- Custom cutting is available from 2450mm and 3060mm lengths

N15-070 Polyurethane adhesive fixing
N15-070P Punched for screw fixing

N15-050 Step Edge Contrast 64mm

Available in standard lengths from 800mm to 1500mm in 100mm increments

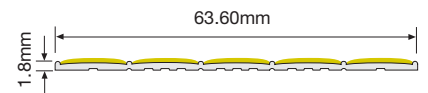
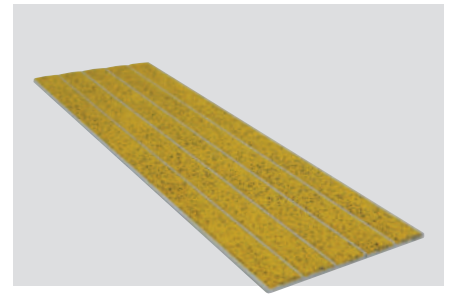

- Adhesive and caulking gun available separately
- Custom cutting is available from 2450mm and 3060mm lengths

N15-070 Polyurethane adhesive fixing
N15-070P Punched for screw fixing

For compliance information see product data sheets (downloadable from PRODUCTS section on website)

Handrail Markers and Guidance Strips

H3-001 Handrail Marker 16mm

Available in 1000mm and 3060mm lengths

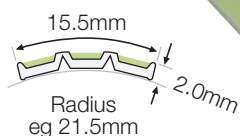
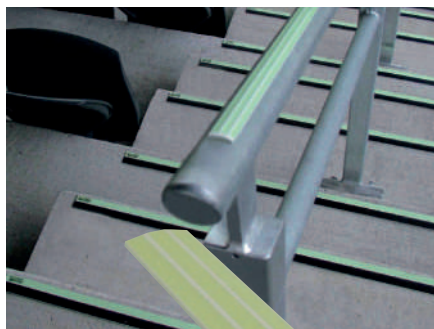

- H3-001-1000** Polyurethane adhesive fixing
- H3-001-3060** Polyurethane adhesive fixing
- H3-001T-1000** Release tape pre-fitted
- H3-001T-3060** Release tape pre-fitted

HREC3 Metal End Cap



END CAPS
Metal end cap
to fit H3-001

H5-001 Handrail Marker 127mm

Available in 1000mm and 3060mm lengths

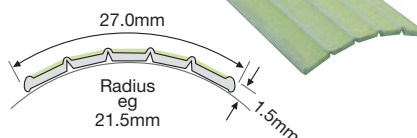

- H5-001-1000** Polyurethane adhesive fixing
- H5-001-3060** Polyurethane adhesive fixing
- H5-001T-1000** Release tape pre-fitted
- H5-001T-3060** Release tape pre-fitted

HEC5 Plastic End Cap



END CAPS
Plastic end cap
to fit H5-001

MS-26 Handrail Wall Strip 26mm

Available in 1000mm lengths

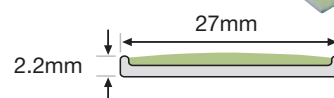
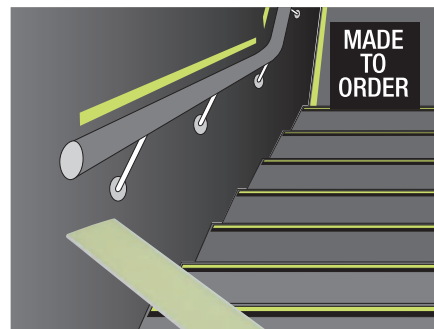

- MS-26T-1000** Release tape pre-fitted

G3-001 Guidance Strip 16mm

Available in 1000mm and 3060mm lengths

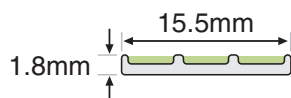

- G3-001-1000** Polyurethane adhesive fixing
- G3-001-3060** Polyurethane adhesive fixing
- G3-001P-1000** Punched for screw fixing
- G3-001P-3060** Punched for screw fixing
- G3-001T-1000** Release tape pre-fitted
- G3-001T-3060** Release tape pre-fitted

G6-003 Guidance Strip 26mm

Available in standard lengths from 800mm to 1500mm in 100mm increments

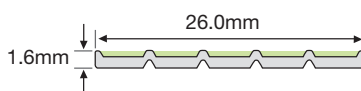
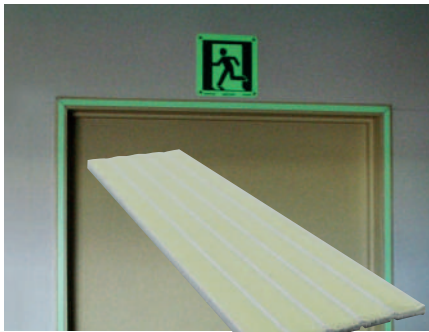

Custom cutting is available from 3060mm lengths

- G6-003** Polyurethane adhesive fixing
- G6-003P** Punched for screw fixing
- G6-003T** Release tape pre-fitted

For compliance information see product data sheets (downloadable from PRODUCTS section on website)

Path Markers

T6-101 Path Marker

Available in 1000mm lengths

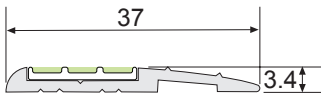
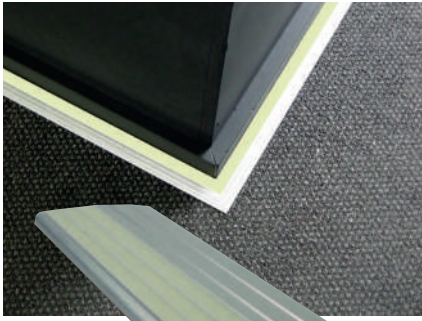

T6-101-1000 Polyurethane adhesive fixing
T6-101P-1000 Punched for screw fixing

T5-101 Path Marker

Available in 1000mm lengths

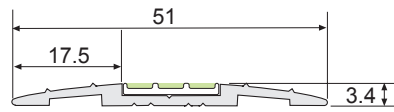

T5-101-1000 Polyurethane adhesive fixing
T5-101P-1000 Punched for screw fixing

G7-100 Solaris Path Marker

Available in 100mm lengths in packs of 10 pieces

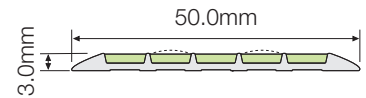
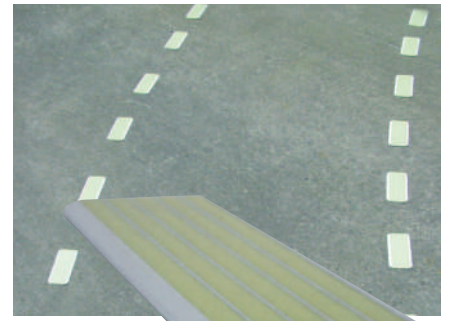

G7-100 Polyurethane adhesive fixing
G7P-100 Punched for screw fixing
G7T-100 Release tape pre-fitted

Door Handle Markers

Door Handle Marker

Use this to highlight a door handle in an emergency

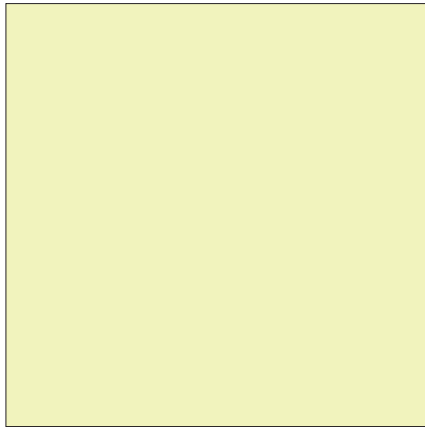

100mm x 100mm

S5-DHM1010 Release tape pre-fitted

Door Handle Marker

Use this to highlight a door handle in an emergency



60mm x 60mm

S20-SQ-60 - Release tape pre-fitted

Vinyl Push Bar Marker

Use this to highlight a door push bar



38mm x 407mm
 Supplied with pre-fitted release tape

Non-HTC product

UL-DHM3840 - Door Push Bar Marker

UL 1994 PL Egress Signs



Pictogram
Exit straight on from here
Product No. S5-RM2010
Size 200mm x 100mm

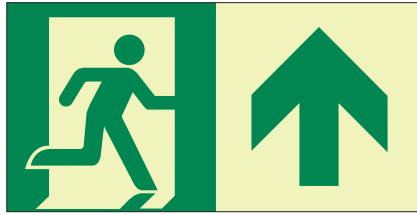

Pictogram Up Arrow
Exit straight on up from here
Product No. S5-RMUA2010
Size 200mm x 100mm



Pictogram Down Arrow
Exit down from here
Product No. S5-RMDA2010
Size 200mm x 100mm



Pictogram Up Left Arrow
Exit up left from here
Product No. S5-RMUL2010
Size 200mm x 100mm



Pictogram Down Left Arrow
Exit down left from here
Product No. S5-RMDL2010
Size 200mm x 100mm



Pictogram Up Right Arrow
Exit up right from here
Product No. S5-RMUR2010
Size 200mm x 100mm

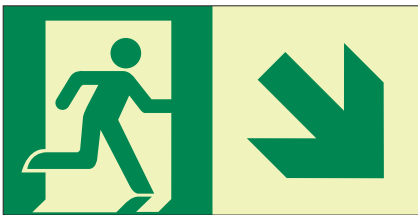

Pictogram Down Right Arrow
Exit down right from here
Product No. S5-RMDR2010
Size 200mm x 100mm



Pictogram Left Arrow
Exit left from here
Product No. S5-RML2010
Size 200mm x 100mm



Pictogram Right Arrow
Exit right from here
Product No. S5-RMR2010
Size 200mm x 100mm

For compliance information see product data sheets (downloadable from PRODUCTS section on website)

Directional Signs



**Directional Pictogram
Left Facing**
Exit straight on from here
Product No. S5-RML1010
Size 100mm x 100mm



**Directional Pictogram
Right Facing**
Exit straight on from here
Product No. S5-RMR1010
Size 100mm x 100mm

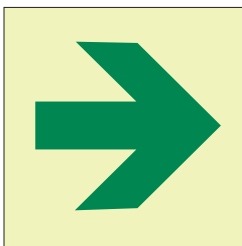

Directional Arrow Straight
Travel in this direction
Product No. S5-ARS1010
Size 100mm x 100mm

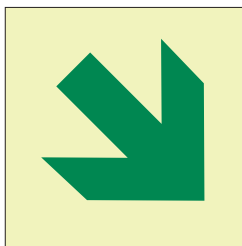

Directional Arrow Diagonal
Travel in this direction
Product No. S5-ARD1010
Size 100mm x 100mm

Stairway Identification Sign

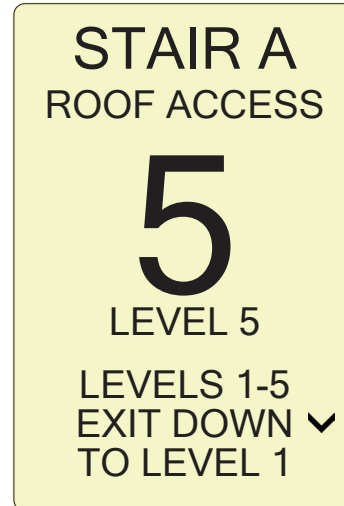

Stairway Identification
Product No. S5-SI4631
Size 460mm x 310mm

**MADE
TO
ORDER**

Miscellaneous Products

Vinyl Hazard Tape

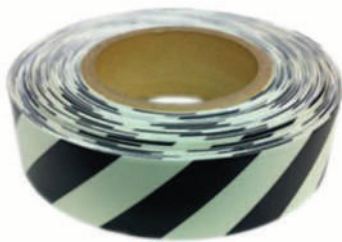

UL-HZ2518 Hazard Tape
25mm x 18m roll of photoluminescent
adhesive vinyl tape

Use this to highlight obstacles
along the escape route

Non-HTC product

UL-HZ2518 25mm wide x 18m roll

Vinyl Photoluminescent Tape



**UL-PT2518
Photoluminescent Tape**
25mm x 18m roll of photoluminescent
adhesive vinyl tape

Use this to highlight specified features
in escape routes

Non-HTC product

UL-PT2518 25mm wide x 18m roll

Adhesive for Emergency Visibility Products



Caulking Gun
CLKGUN-600ml
To take 600ml Adhesive Sausage

Polyurethane Adhesive

890100182KD



For compliance information see product data sheets (downloadable from PRODUCTS section on website)

UL 924 PL Exit Signs

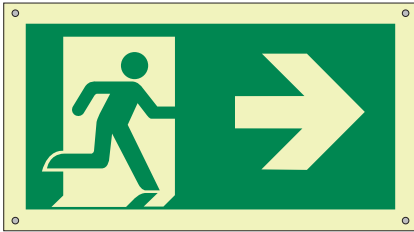

Pictogram Right Arrow

Exit right from here

Maximum Viewing Distance: 50 feet

Product No: S20-UL-RMR392223-50

Size 392mm x 223mm

Maximum Viewing Distance: 75 feet

Product No: S20-UL-RMR480280-75

Size 480mm x 280mm

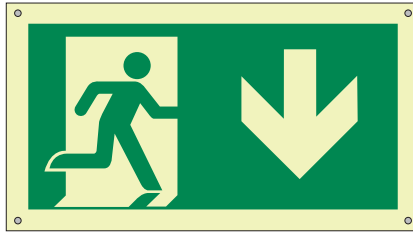

Pictogram Down Arrow

Exit down from here

Maximum Viewing Distance: 50 feet

Product No: S20-UL-RMDA392223-50

Size 392mm x 223mm

Maximum Viewing Distance: 75 feet

Product No: S20-UL-RMDA480280-75

Size 480mm x 280mm

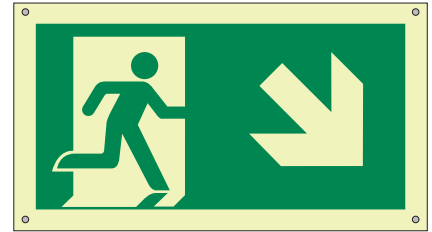

Pictogram Down Right Arrow

Exit down right from here

Maximum Viewing Distance: 50 feet

Product No: S20-UL-RMDR392223-50

Size 392mm x 223mm

Maximum Viewing Distance: 75 feet

Product No: S20-UL-RMDR480280-75

Size 480mm x 280mm



Pictogram Left Arrow

Exit left from here

Maximum Viewing Distance: 50 feet

Product No: S20-UL-RML392223-50

Size 392mm x 223mm

Maximum Viewing Distance: 75 feet

Product No: S20-UL-RML480280-75

Size 480mm x 280mm



Pictogram Up Right Arrow

Exit up right from here

Maximum Viewing Distance: 50 feet

Product No: S20-UL-RMUR392223-50

Size 392mm x 223mm

Maximum Viewing Distance: 75 feet

Product No: S20-UL-RMUR480280-75

Size 480mm x 280mm

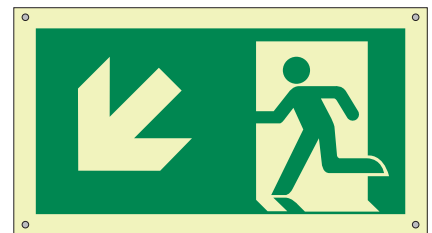

Pictogram Down Left Arrow

Exit down left from here

Maximum Viewing Distance: 50 feet

Product No: S20-UL-RMDL392223-50

Size 392mm x 223mm

Maximum Viewing Distance: 75 feet

Product No: S20-UL-RMDL480280-75

Size 480mm x 280mm

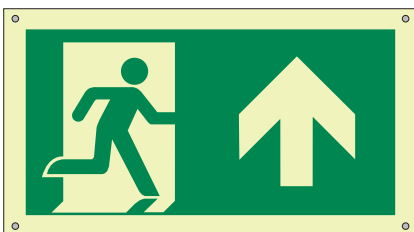

Pictogram Up Arrow

Exit straight on from here

Maximum Viewing Distance: 50 feet

Product No: S20-UL-RMUA392223-50

Size 392mm x 223mm

Maximum Viewing Distance: 75 feet

Product No: S20-UL-RMUA480280-75

Size 480mm x 280mm

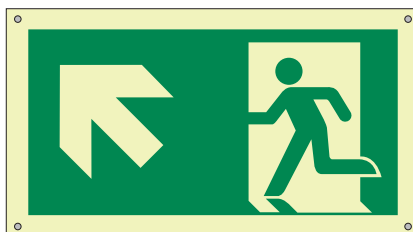

Pictogram Up Left Arrow

Exit up left from here

Maximum Viewing Distance: 50 feet

Product No: S20-UL-RMUL392223-50

Size 392mm x 223mm

Maximum Viewing Distance: 75 feet

Product No: S20-UL-RMUL480280-75

Size 480mm x 280mm



Exit

Exit straight on from here

Maximum Viewing Distance: 50 feet

Product No: S20-UL-EX353183-50

Size 353mm x 183mm

Maximum Viewing Distance: 75 feet

Product No: S20-UL-EX481249-75

Size 481mm x 249mm

For compliance information see product data sheets (downloadable from PRODUCTS section on website)

UL 924 PL Exit Signs



Exit Left

Exit left from here

Maximum Viewing Distance: 50 feet
Product No: S20-UL-EXL353183-50
Size 353mm x 183mm

Maximum Viewing Distance: 75 feet
Product No: S20-UL-EXL481249-75
Size 481mm x 249mm



Exit Right

Exit right from here

Maximum Viewing Distance: 50 feet
Product No: S20-UL-EXR353183-50
Size 353mm x 183mm

Maximum Viewing Distance: 75 feet
Product No: S20-UL-EXR481249-75
Size 481mm x 249mm



Exit Double Arrow

Exit straight on from here

Maximum Viewing Distance: 50 feet
Product No: S20-UL-EXRL353183-50
Size 353mm x 183mm

Maximum Viewing Distance: 75 feet
Product No: S20-UL-EXRL481249-75
Size 481mm x 249mm

For compliance information see product data sheets (downloadable from PRODUCTS section on website)

Mounting / Hanging Options

Standard Mounting Brackets



CEILING MOUNT

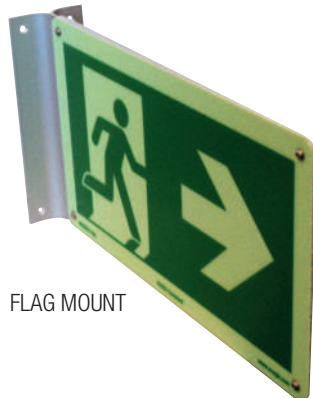

FLAG MOUNT

Chain Suspension for Signs

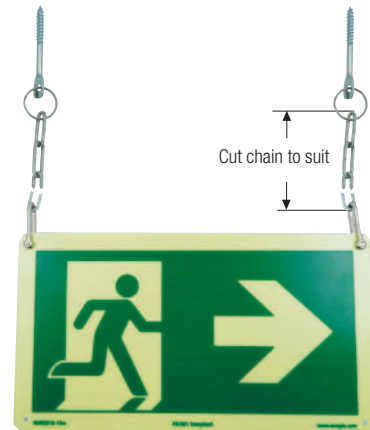

All UL924 and S20 signs include fixers for mounting the sign flat against a wall or other surface. Mounting brackets and chain suspension is also available (sold separately).

Contact info@ecoglo.com for more information

S20 PL Standard Exit Signs



Exit

Exit straight on from here
 Maximum Viewing Distance: 16 metres
 Product No: S20-EX2313-16m
 Size 230mm x 133mm

Maximum Viewing Distance: 24 metres
 Product No: S20-EX2916-24m
 Size 290mm x 162mm



Pictogram Uni

Exit straight on from here
 Maximum Viewing Distance: 16 metres
 Product No: S20-RM1616UN-16m
 Size 162mm x 162mm

Maximum Viewing Distance: 24 metres
 Product No: S20-RM2323UN-24m
 Size 230mm x 230mm



Arrow

Travel in this direction
 Product No: S20-AR1313
 Size 133mm x 133mm
 For use with: S20-EX2313-16m

Product No: S20-AR1616
 Size 162mm x 162mm
 For use with: S20-RM1616-16m
 and S20-EX2916-24m

Product No: S20-AR2323
 Size 230mm x 230mm
 For use with: S20-RM4223-24m



Pictogram

Exit straight on from here
 Maximum Viewing Distance: 16 metres
 Product No: S20-RM2916-16m
 Size 290mm x 162mm

Maximum Viewing Distance: 24 metres
 Product No: S20-RM4223-24m
 Size 420mm x 230mm

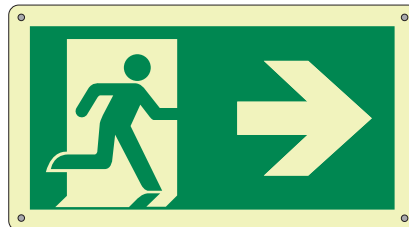

Pictogram Right

Exit right from here
 Maximum Viewing Distance: 16 metres
 Product No: S20-RMR2916-16m
 Double Sided DSS20-RMD2916-16m
 Size 290mm x 162mm

Maximum Viewing Distance: 24 metres
 Product No: S20-RMR4223-24m
 Double Sided DSS20-RMD4223-24m
 Size 420mm x 230mm



Pictogram Left

Exit left from here
 Maximum Viewing Distance: 16 metres
 Product No: S20-RML2916-16m
 Double Sided DSS20-RMD2916-16m
 Size 290mm x 162mm

Maximum Viewing Distance: 24 metres
 Product No: S20-RML4223-24m
 Double Sided DSS20-RMD4223-24m
 Size 420mm x 230mm

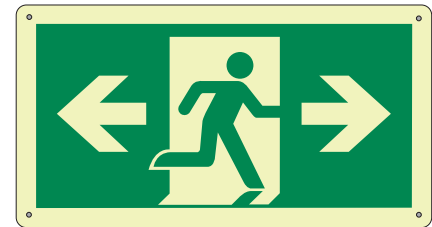

Pictogram Double Arrow

Exit right or left from here
 Maximum Viewing Distance: 16 metres
 Product No: S20-RMRL2916-16m
 Double Sided: DSS20-RMRL2916-16m
 Size 290mm x 162mm

Maximum Viewing Distance: 24 metres
 Product No: S20-RMRL4223-24m
 Double Sided: DSS20-RMRL4223-24m
 Size 420mm x 230mm

Hybrid PL Exit Signs

The Hybrid PL Exit Sign combines Ecoglo's internationally recognised photoluminescent technology with Class II LEDs and the next generation patented electronics. Requiring no backup, the internally illuminated photoluminescent exit sign is effective in all lighting scenarios.

Non-HTC product



Can be surface, ceiling or flag mounted



Sign can also be recessed into ceiling

The Hybrid PL exit sign is available single sided or double sided with a range of mounting options to satisfy architectural requirements. (see product codes below)

Single sided sign (HYU1.2) or Double sided sign (HYU2.2)

Flag mount kit: BR3-16m-FM

Ceiling recess kit: BR3-16m-CR

(Wall and ceiling mounting options included with sign)

Signs include one or more of graphics shown below.



RM
Exit straight on from here



RML
Exit left from here



RMR
Exit right from here



RM DOUBLE ARROW
Exit right or left from here



RM (Low Light)
Exit straight on from here



EXIT (Low Light)
Exit straight on from here



EXIT
Exit straight on from here



EXIT LEFT
Exit left from here



EXIT RIGHT
Exit right from here

CEILING AND WALL MOUNT

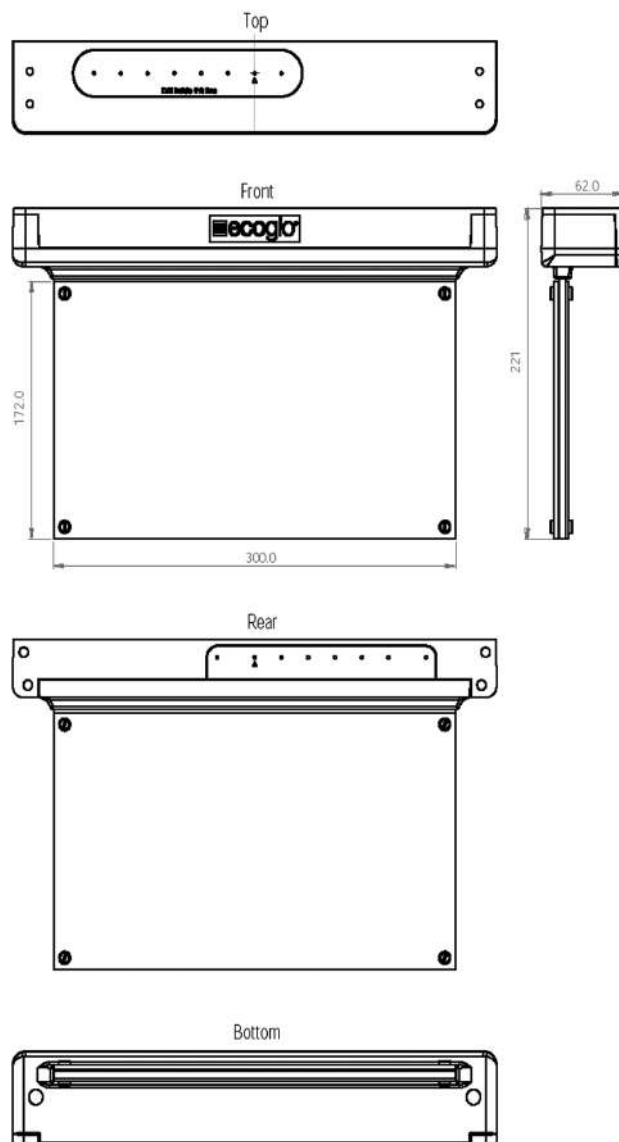

For compliance information see product data sheets (downloadable from PRODUCTS section on website)

Fire Protection Signs



Fire Extinguisher
 Fire extinguisher located here
 Product No. S5-FEXT2010
 Size 200mm x 100mm



Fire Extinguisher
 Fire extinguisher located here
 Product No. BR5-DS-S5-FEXT2010
 Size 200mm x 100mm (each side)

MADE TO ORDER



Break Glass
 In case of emergency break glass
 Product No. S5-BG1010
 Size 100mm x 100mm



Fire Hose
 Fire hose located here
 Product No. S5-FH1010
 Size 100mm x 100mm

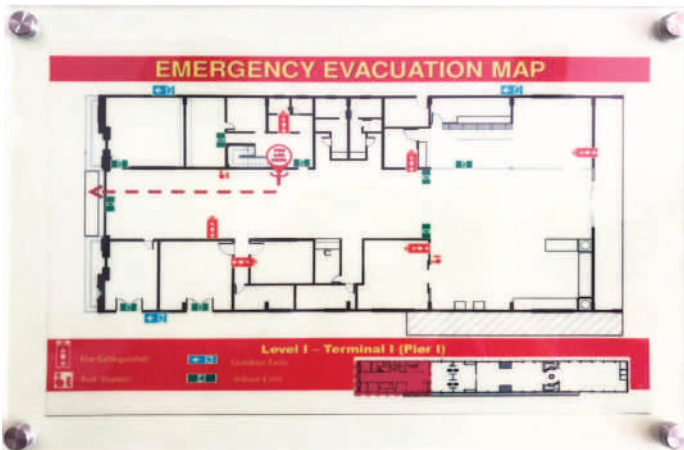

Evacuation Map
 (Aluminium Sheet)

Emergency Evacuation Plan
 Product No. S5-EVAC216330
 Size 216mm x 330mm
 Product No. S5-EVAC457610
 Size 457mm x 610mm
 Product No. S5-EVAC610915
 Size 610mm x 915mm

Evacuation Map
 (Rigid PVC with acrylic overlay)*

Emergency Evacuation Plan
 Product No. G20-EVAC216330
 Size 216mm x 330mm
 Product No. G20-EVAC457610
 Size 457mm x 610mm
 Product No. G20-EVAC610914
 Size 610mm x 915mm

* Non-HTC product



Fire Alarm
 Fire alarm located here
 Product No. S5-FA1010
 Size 100mm x 100mm

MADE TO ORDER

See also UL 1994 Signs and Directional Signs on pages 8 and 9

For compliance information see product data sheets (downloadable from PRODUCTS section on website)

Disaster Preparedness Signs

MADE
TO
ORDER

Tsunami Hazard Zone



Product No: S20-THZ315290 Size 315mm x 290mm

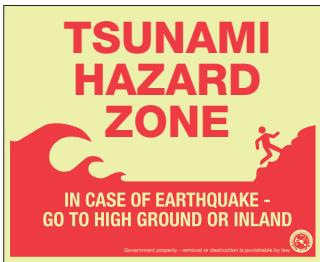

Product No: S20-THZ588475 Size 588mm x 475mm

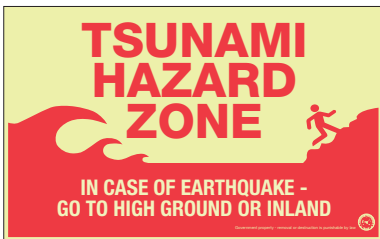

Product No: S20-THZ950588 Size 950mm x 588mm



Product No: S20-THZ1190980 Size 1190mm x 980mm



Product No: S20-THZ2380980 Size 2380mm x 980mm

Landslide Warning



Product No: S20-LS315290 Size 315mm x 290mm



Product No: S20-LS588475 Size 588mm x 475mm



Product No: S20-LS950588 Size 950mm x 588mm



Product No: S20-LS1190980 Size 1190mm x 980mm



Product No: S20-LS2380980 Size 2380mm x 980mm

Please note graphics above are examples only. Customisation of the artwork is available for different provinces, regions or offices. Contact Ecoglo for more information.

For compliance information see product data sheets (downloadable from PRODUCTS section on website)

Disaster Preparedness Signs

MADE TO ORDER

Evacuation Area Straight Ahead



Product No: S20-EA315290 Size 315mm x 290mm



Product No: S20-EA588475 Size 588mm x 475mm



Product No: S20-EA950588 Size 950mm x 588mm



Product No: S20-EA1190980 Size 1190mm x 980mm



Product No: S20-EA2380980 Size 2380mm x 980mm

Evacuation Area Left



Product No: S20-EAL315290 Size 315mm x 290mm



Product No: S20-EAL588475 Size 588mm x 475mm



Product No: S20-EAL950588 Size 950mm x 588mm



Product No: S20-EAL1190980 Size 1190mm x 980mm



Product No: S20-EAL2380980 Size 2380mm x 980mm

Please note graphics above are examples only. Customisation of the artwork is available for different provinces, regions or offices. Contact Ecoglo for more information.

For compliance information see product data sheets (downloadable from PRODUCTS section on website)

Disaster Preparedness Signs

MADE TO ORDER

Evacuation Area Right



Product No: S20-EAR315290 Size 315mm x 290mm



Product No: S20-EAR588475 Size 588mm x 475mm



Product No: S20-EAR950588 Size 950mm x 588mm



Product No: S20-EAR1190980 Size 1190mm x 980mm



Product No: S20-EAR2380980 Size 2380mm x 980mm

Tsunami Evacuation Route



Exit straight ahead from here
Product No. TE315155 Size 315mm x 155mm



Exit left from here
Product No. TEL315155 Size 315mm x 155mm



Exit right from here
Product No. TER315155 Size 315mm x 155mm

Water Depth Gauge



Product No: S20-WDG
Size 115mm x 1000mm

Note: Image is for illustration purposes only. Each Water Depth Gauge is custom printed to specific requirements for each location.

Please note graphics above are examples only. Customisation of the artwork is available for different provinces, regions or offices. Contact Ecoglo for more information.

For compliance information see product data sheets (downloadable from PRODUCTS section on website)

Disaster Preparedness Signs

MADE TO ORDER

Warning! Flood Prone Area



Product No: S20-FPA315290 Size 315mm x 290mm



Product No: S20-FPA588475 Size 588mm x 475mm



Product No: S20-FPA950588 Size 950mm x 588mm



Product No: S20-FPA1190980 Size 1190mm x 980mm



Product No: S20-FPA2380980 Size 2380mm x 980mm

House Number Sign

MADE TO ORDER

House Number Sign

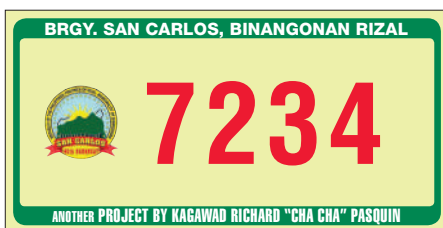

Product No: S10-HN2010 Size 200mm x 100mm

Please note graphics above are examples only. Customisation of the artwork is available for different provinces, regions or offices. Contact Ecoglo for more information.

For compliance information see product data sheets (downloadable from PRODUCTS section on website)

Stadium and Venue Markers

MADE
TO
ORDER

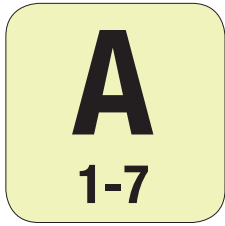

Row and Seat Marker
Product No: SQ90RSP
Size 90mmx90mm

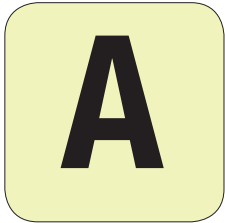

Row Marker
Product No: SQ90R
Size 90mmx90mm

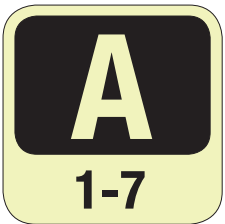

Row and Seat Marker
Product No: SQ90RSN
Size 90mmx90mm

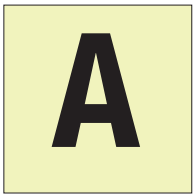

Row Marker
Product No: SQ63R
Size 63mmx63mm

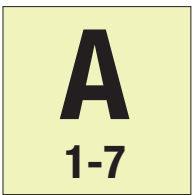

Row and Seat Marker
Product No: SQ63RSP
Size 63mmx63mm

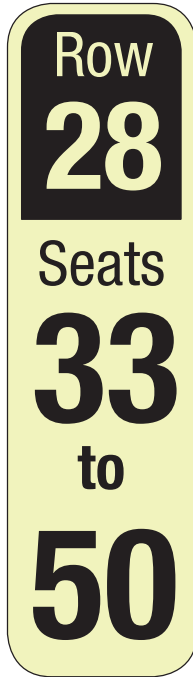

Row and Seat Marker
Product No: RE16045-RS
Size 160mmx45mm



Ellipse Seat Marker
Product No: EL187567
Size 18.7mmx56.7mm



Note: SQ63R and SQ63RSP markers can fit into F14 and F15 Step Nosings alongside step edge contrast (as above).

Note: All stadium and venue markers are made to order.
See also Step Edge Products, Handrail Markers, Guidance Strips,
Path Markers and Signage elsewhere in this brochure.

Ecoglo International Limited

Warranty for Photoluminescent Performance of HTC* Signs and Products

1. We warrant the photoluminescent performance of both Signs and Products, manufactured using our High Temperature Curing (HTC) process, for a period of:
thirty years from the date of installation for standard Signs and Products which are positioned **indoors**; and **fifteen** years from the date of installation for **outdoor** Signs (specially coated for outdoor conditions) and Products which are positioned **outdoors**.
2. This warranty assumes correct installation and normal conditions of use and maintenance but does not cover normal wear and tear. This warranty does not cover deterioration due to abuse, mistreatment, natural disasters (e.g. fire, flood), exposure to harmful chemicals or environments or any other use or exposure not recommended in our product literature. In particular, this warranty is void in the following circumstances:
 - 2.1 The Signs and/or Products have been misused, neglected, damaged, abused or involved in an accident.
 - 2.2 The Signs and/or Products have been improperly installed, operated, repaired or maintained.
 - 2.3 The Signs and/or Products have been modified.
 - 2.4 The Signs and/or Products have been used outside their stated specifications, capacity and operating parameters.
3. If you have a claim that, in our reasonable judgement, satisfies the terms of this warranty, we shall replace the defective Sign or Product (material only).
4. This is an express warranty. It is your sole and exclusive remedy. We disclaim any other express or implied warranties, including warranties of merchantability or fitness for purpose, to the maximum extent permitted by law. Under no circumstances shall we accept liability for any injury to persons, damage to property, loss of profits, loss of operations or other direct, indirect, special, incidental, or consequential losses, costs and damages whether incurred by you, your guests, licensees, invitees or other third parties. Our liability under any circumstance, whether in contract, tort or otherwise, shall not, in the aggregate, exceed the price that you paid for the Sign and/or Product.
5. Some countries do not allow certain disclaimers, limitations or exclusions in warranties. Therefore, the above disclaimers, limitations and exclusions may not apply to you. This warranty gives you specific legal rights. You may have other rights or remedies pursuant to the laws of your country. Nothing in this limited warranty should be construed as limiting or restricting any other right or remedy available to you, except as allowed by the law in your country.

*Manufactured using High Temperature Curing (HTC)



Ecoglo Fire Protection Product Trading

36 C Gloria St., Brgy. San Carlos, Binangonan Rizal 1940 Philippines

HTC (High Temperature Curing)

The patented manufacturing process used to make Ecoglo's products is known as High Temperature Curing or HTC.

HTC involves the precisely controlled application of a powder mix of customised photoluminescent pigments and customised carriers (referred to as Purpose Designed Polymer or PDP) onto an aluminium base.

The polymer mix and aluminium base pass through a bespoke oven to be baked at temperatures above 160°C. This high temperature curing process integrally bonds the polymer mix to the aluminium, eliminating the possibility of peeling, shrinkage or delamination. It also provides permanent protection of the photoluminescent pigments from degradation due to moisture or weathering.

These performance properties cannot be guaranteed for photoluminescent PVC products and tapes.

HTC products won't suffer from shrinkage, delamination or discolouring and are therefore more durable delivering higher and more reliable luminance.



The following Ecoglo product ranges are Certified HTC

- Step Edge Contrast
- Step Nosings
- Handrail Markers
- Guidance Strips
- Path Markers
- S5-DHM1010 Door Handle Marker
- S20-SQ-60 Door Handle Marker
- Directional Signs
- Stairway Identification Signs
- Fire Protection Signs*
- UL 924 Signs
- UL 1994 Exit Signs
- S5 Exit Signs
- S20 Exit Signs
- Disaster Preparedness Signs
- Row and Seat Markers
- House Number Sign

**Note G20 Evacuation Map is not HTC as it isn't aluminium*

Whatsapp Chat: <https://wa.me/message/RYGJKOJU7EGBL1>

Scan QR Code for Viber Chat:



Ecoglo Fire Protection Product Trading

Address: 36-C Gloria Street, Barangay San Carlos,
Binangonan Rizal 1940, Philippines

Office: +632-8802-4760

Cell: +63917-514-6803
+63968-356-4773

Email: keith.phillips@ecoglo.com

Web: www.ecoglo.ph www.EcogloAsia.com www.EcogloVenues.com